

LAUMAS

PALLET SCALE

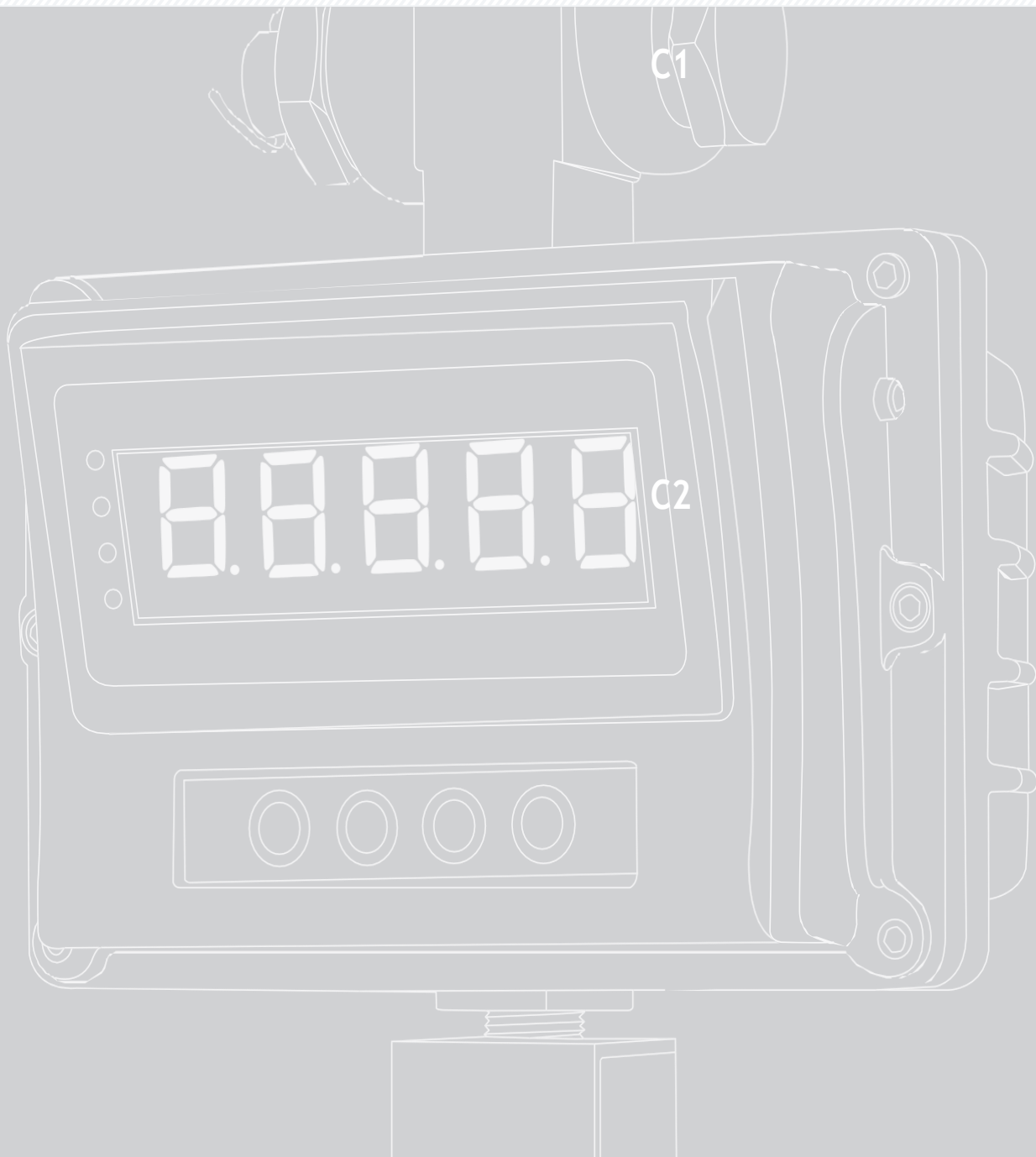



Capacity up to 3000 kg

- **PX:**
 - Painted steel structure.
 - 4 load cells FTP 1000 kg
AISI 420 stainless steel - IP68 (on request: IP69K).
 - Galvanized steel adjustable feet,
self-centering on sphere.
- **PXI:**
 - AISI 304 stainless steel structure.
 - 4 load cells FT-P 1000 kg
17-4 PH stainless steel - IP68 (on request: IP69K).
 - AISI 304 stainless steel adjustable feet,
self-centering on sphere.
- IP67 stainless steel junction box with equalization board and 6-wire output cable (length: 5 m).
- Carrying handle and wheels.

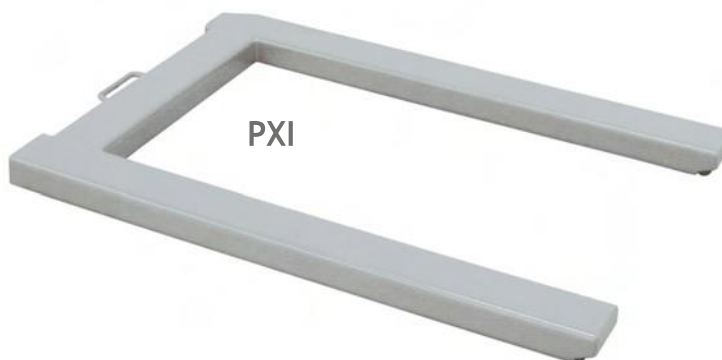
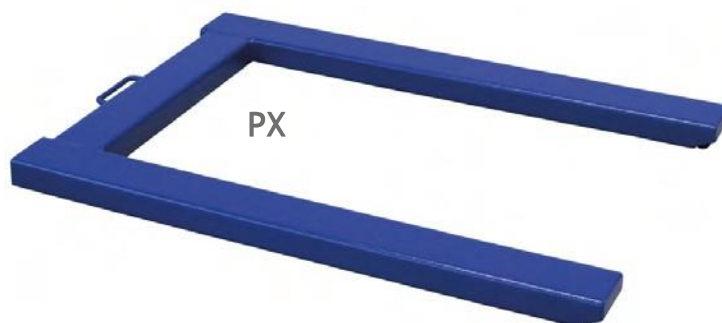

CAPACITY	kg	ACCURACY CLASS		DIMENSION (mm)	NET WEIGHT (kg)	CODE
3000		G3		1250 x 840	38	PX
3000		•	•	1250 x 840	38	PXI

CERTIFICATIONS



OIML R60 C3

CERTIFICATIONS ON REQUEST



Declaration of conformity + IP69K marking protection rating

Water protection in case of high-pressure or steam jet cleaning (test: pressurized water is sprayed from a distance of max 150 mm)
Water pressure: 100 bar; temperature: 80 °C; test duration: 250 seconds (reference standard: DIN 40050-9)



ATEX II 2GD (zone 1-2-21-22)

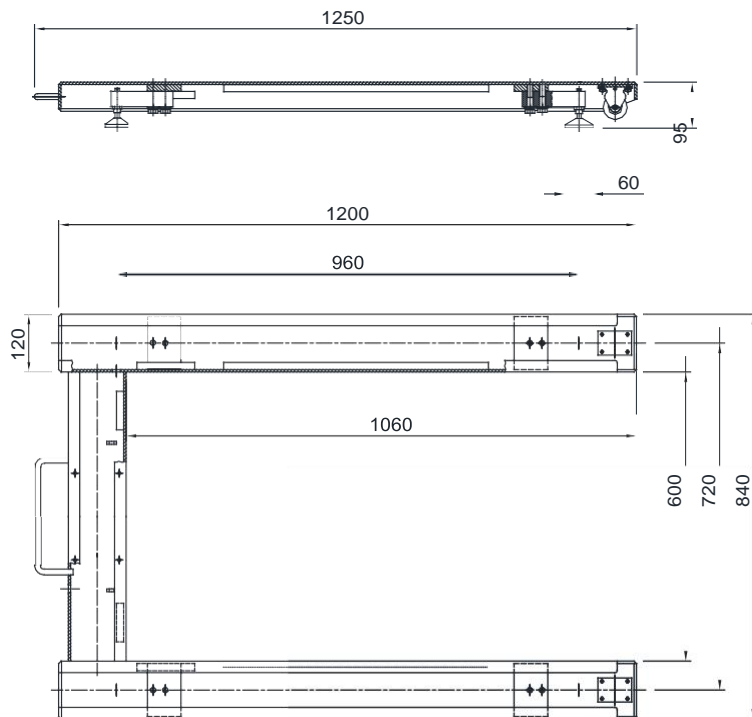
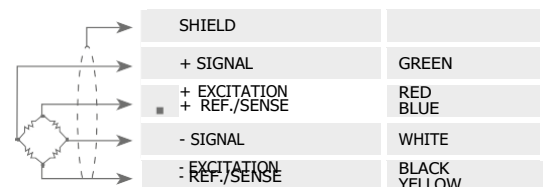

IECEx (zone 1-2-21-22)

DIMENSIONS (mm)**ELECTRICAL CONNECTIONS**

■ where provided

**OPTIONS ON REQUEST**

	DESCRIPTION	CODE
	Stainless steel indicator-holder column (Ø38 mm, height 700 mm). Painted steel mobile pedestal.	COLONNAM + MOBILCOLONNA COLONNAM + MOBILCOLONNAINOX
	Non-standard capabilities.	

LAUMAS®

Innovation in Weighing

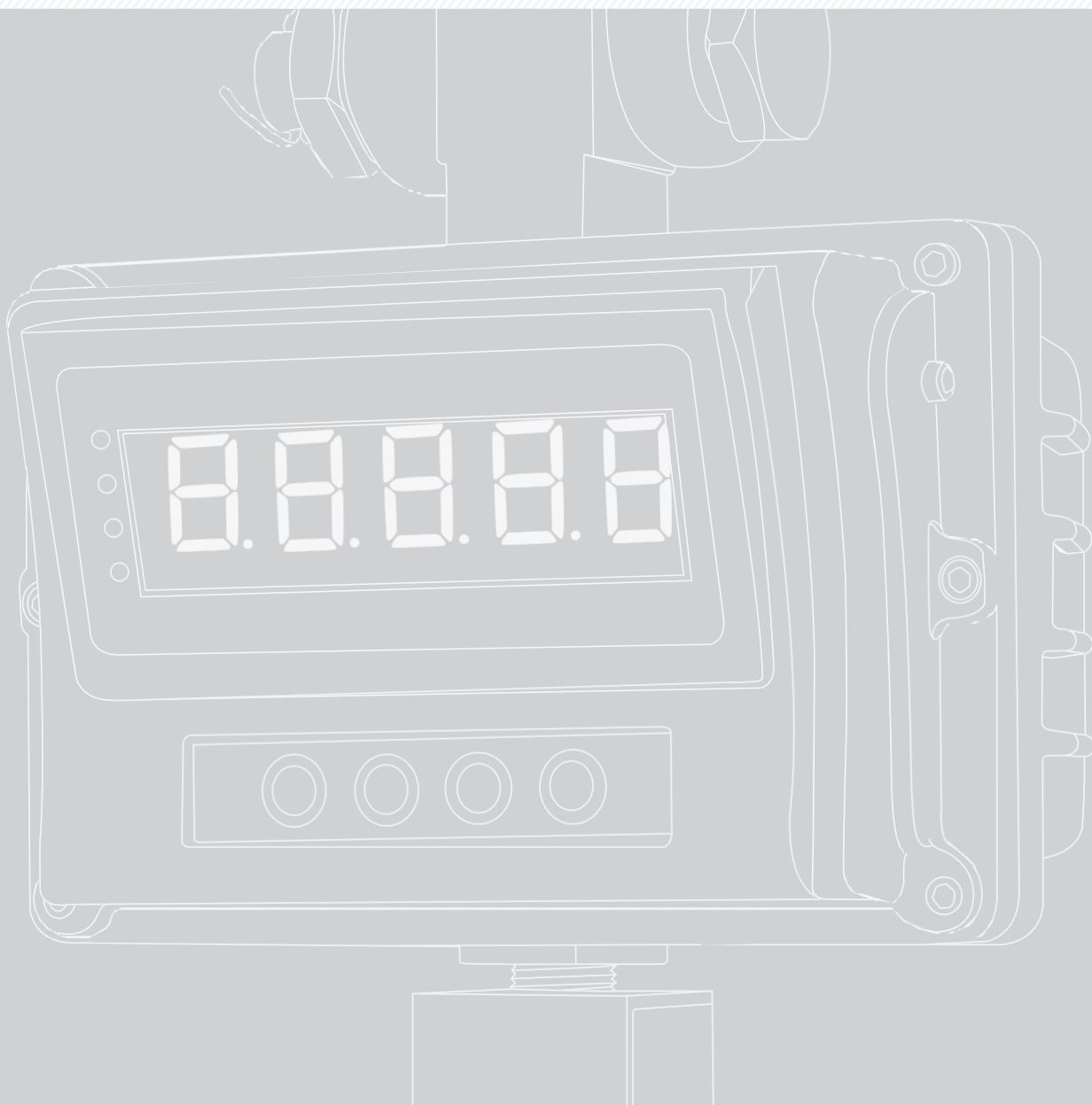

PT. Panatron Mekatronik Pastima

Sentra Niaga SN 5.9 No.17, Harapan Indah
Bekasi, 17214

PHONE (+62) 21 29477414

WA (+62) 821 2381 0564

SALES DEPARTMENT: sales@panatronik.com